



# Quick Guide

## Lumify Ultrasound System

English

**PHILIPS**



## Contents

### Getting Started

System Components .....	3
Connecting a Transducer .....	4
Registering Transducers .....	5

### Controls

Imaging Controls .....	7
------------------------	---

### Patient Exams

Starting Exams .....	9
Resuming a Paused Exam .....	10
Ending an Exam .....	11
Acquiring Images and Loops .....	12
Reviewing Exams .....	13
Exporting Images and Loops .....	14

### Imaging Basics

Focus Depth and Brightness .....	15
Zoom .....	15
Imaging Modes .....	16

### Measurements

2D Distance Measurements .....	17
2D Ellipse Measurements .....	18

### Lumify Tele-Ultrasound Powered by Reacts

Lumify with Reacts .....	19
Reacts Controls and Status Icons .....	20
Redeeming or Sharing Reacts Access Codes .....	22
Logging In to Reacts .....	23
Managing Reacts Contacts .....	24
Starting and Ending a Reacts Session .....	25
Using the Reacts Pointer Tool .....	26
Sharing Camera and Ultrasound Images .....	27

### Power Management

Extending Battery Life .....	29
Power Management Tips .....	29

## About This Guide

Use this *Quick Guide* to help you perform an ultrasound exam step-by-step. For more information, see the *User Manual*.



Most images of the display show the English interface. Use the images for visual reference. Your display may differ.

### Conventions

These terms are used in this *Quick Guide*:

Term	Description or Action
Image/image area	Ultrasound-scan area on the imaging display
Imaging display	Information displayed on the screen of your device
Select, deselect	Touch an object on the display to highlight, activate, or deactivate the object

These numbering styles are used in this *Quick Guide*:

Style	Description
	Indicates a system component or a display element
	Indicates a step and control location or system component associated with the step shown in an illustration
	Indicates a step with no callout on an illustration

## System Components

- 1 Lumify-compatible device
- 2 Transducer
- 3 USB transducer cable, 1.25 m (4 ft)  
Not available to order
- 4 USB-C transducer cable
- 5 USB Micro-B transducer cable



## Connecting a Transducer

- 1 Connect the USB Micro-B connector of the USB transducer cable, indicated with an arrow, to the receptacle on the transducer.
- 2 Slide the connector housing toward the transducer, until it fits snugly in place.
- 3 Insert the USB transducer cable into the receptacle of your device.
- 4 If prompted, select **Use By Default for This USB Device**.
- 5 Touch **OK**.



## Registering Transducers

- ① If the Lumify app is not on your device, download and install it.
- ② Start the Lumify app.
- ③ Read the **Terms and Conditions**, and then touch **I Agree**.
- ④ If available, touch **Register**.
- ⑤ Connect your Philips transducer to your device and follow the on-screen prompts.
- ⑥ To redeem or share your Reacts access codes (if available), see “Redeeming or Sharing Reacts Access Codes” on page 22.

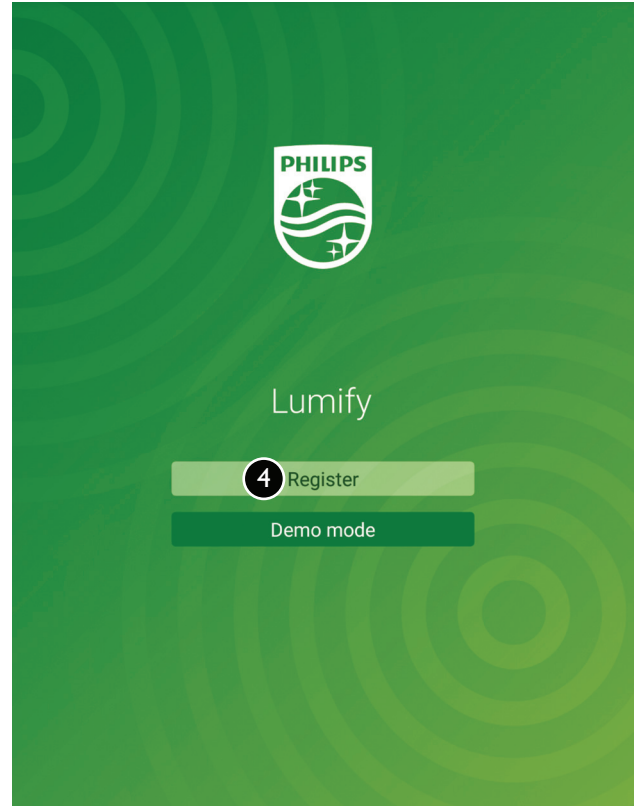



























## Imaging Controls

For information on Reacts controls and status icons, see “Reacts Controls and Status Icons” on page 20.

Control	Description
	Calculates the estimated fetal weight (EFW) from the abdominal circumference ( <b>AC</b> ) of the fetus.
	<b>Annotate</b> adds a label to the acquired image.
	Calculates the estimated fetal weight (EFW) from the biparietal diameter ( <b>BPD</b> ) of the fetus.
	Displays a centerline on the imaging display.
	<b>Clear All</b> removes all measurements performed on the acquired image.
	<b>Confirm Measurement</b> performs fetal analysis from the displayed image.

Control	Description
	<b>Depth</b> adjusts the distance from the face of the transducer to the deepest point on the displayed image.
	Displays two calipers for a 2D <b>Distance</b> measurement from the length of a straight light between the two points.
	<b>Ellipse</b> displays an ellipse for area and circumference measurements.
	<b>End Exam</b> completes the exam.
	<b>Fast Flow</b> overlays a color box, with a high color scale for arterial flow, on the 2D image.
	Calculates the estimated fetal weight (EFW) from the femur length ( <b>FL</b> ) of the fetus.
	Displays the ultrasound image in full-screen view.

Control	Description
	Freezes the image.
	<b>Gain</b> adjusts the image brightness and contrast.
	Calculates the estimated fetal weight (EFW) from the head circumference ( <b>HC</b> ) of the fetus.
	Calculates the last menstrual period ( <b>LMP</b> ) and estimated due date ( <b>EDD</b> ).
	<b>Measure</b> initiates the 2D distance or 2D ellipse measurement tools.
	<b>MMode</b> displays the M-line on the 2D image, and the movement of the anatomy along that line in an M-mode trace.
	Returns to a standard display after full-screen viewing.

Control	Description
	<b>Save Image</b> acquires an image from the current exam.
	<b>Save Loop</b> acquires a loop from the current exam.
	<b>Slow Flow</b> overlays a color box, with a low color scale for venous flow, on the 2D image.

## Starting Exams

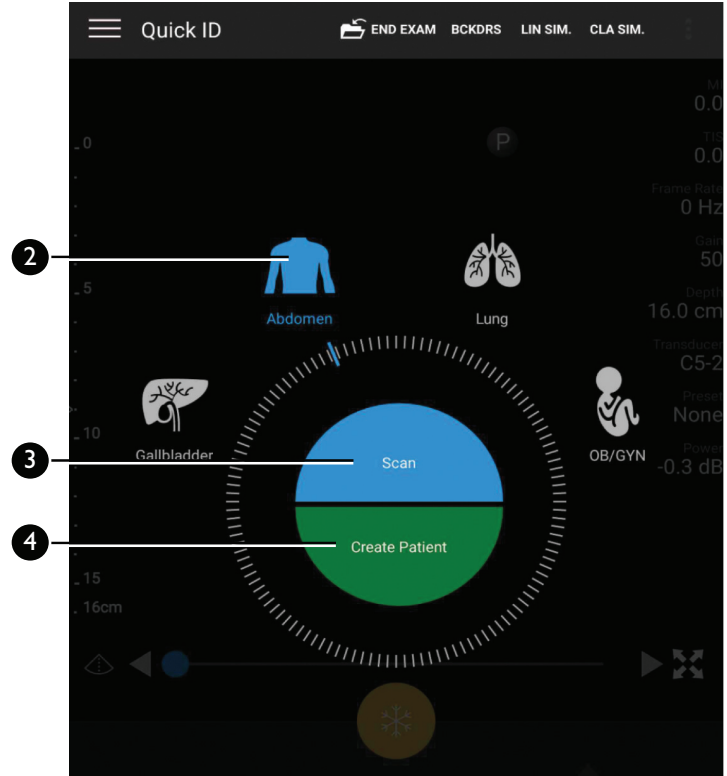

Before starting an exam, connect a transducer to your device. The presets on the **Scan/Create Patient** display are transducer-dependent.

- 1 Connect a transducer to your device.
- 2 On the **Scan/Create Patient** display, touch an exam preset.
- 3 To create a temporary Quick ID and start scanning immediately, touch **Scan**.
- 4 To manually enter patient information before you begin scanning, touch **Create Patient**, enter the patient information, and then touch **Start Exam**.



## Resuming a Paused Exam

If you leave an exam or close the system, you can return to the open exam within 24 hours by doing one of the following:

- 1 Touch  and select **Current Exam** .
- 2 On the **Scan/Create Patient** display, swipe the screen from left to right.

After 24 hours, the system automatically ends the exam.

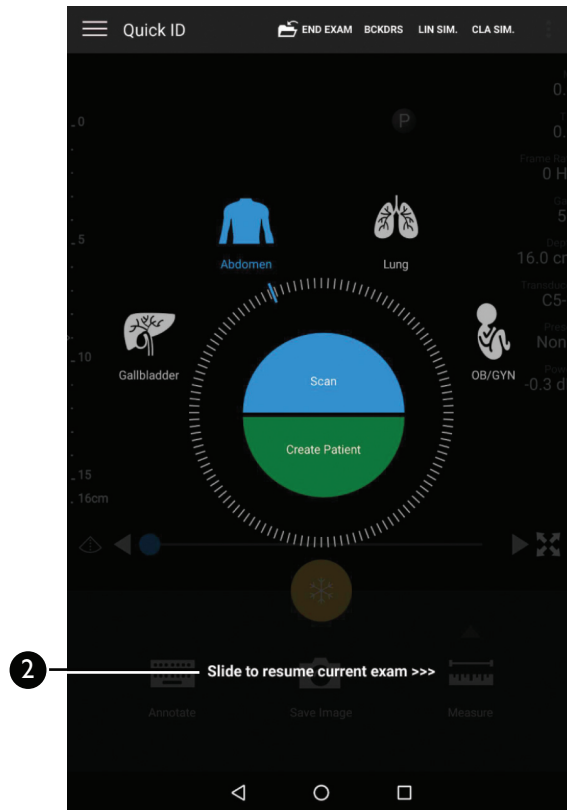

## Ending an Exam

When you are done with an exam, you must end the exam to save images and other exam data.

- 1 On the imaging display, touch **End Exam** .

### NOTES

- If an exam has been open for more than 24 hours, the system automatically ends the exam.
- You cannot append images to an ended exam.

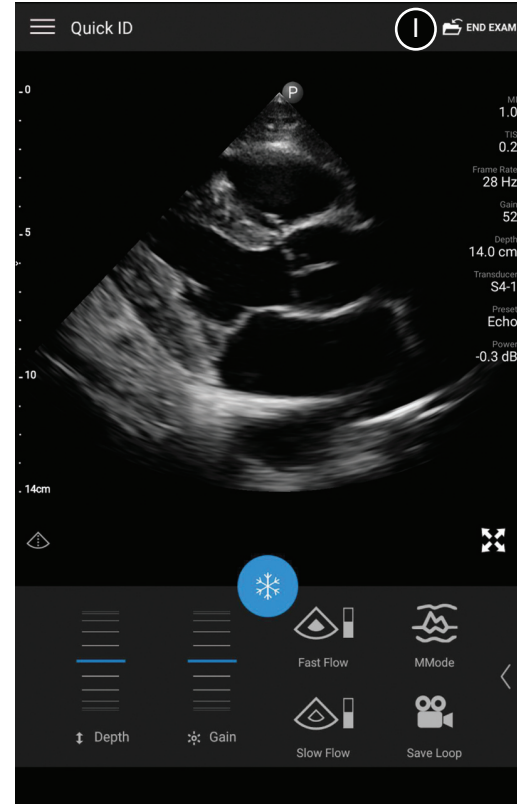

## Acquiring Images and Loops

You can acquire and save images and loops from the current exam. The acquired images and loops are saved in the patient exam and become available in Review.

To acquire images:

- 1 Touch **Save Image** . The system beeps when the image acquisition is complete.

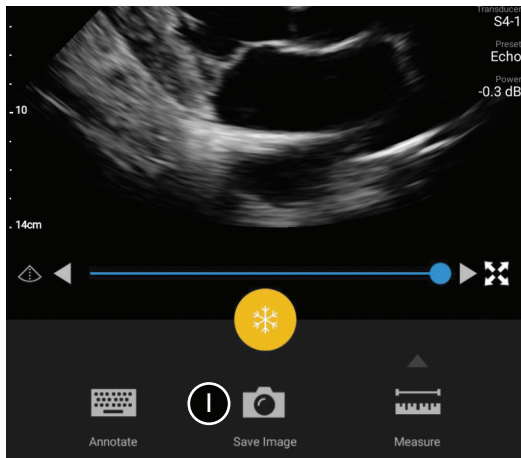







To acquire loops:

- 1 Touch **Save Loop** .
- 2 Touch **Save Loop**  to stop acquisition.

## Reviewing Exams

To start or exit review:

- 1 To start Review during an exam, touch , and then touch **Review Exam** .
- 2 To start review after an exam is ended, touch , touch **Saved Exams** , and then select the exam to review.
- 3 To exit **Review** and return to the current exam, touch , and then touch **Current Exam** .

To view or delete images and loops:

- 1 To scroll through the thumbnails, drag the thumbnails left or right, or up or down, depending on the screen orientation.
- 2 To view a full-size image or loop, touch a thumbnail.
- 3 To delete an image or loop, touch and hold the thumbnail until **Done** appears in the upper left of the display. Touch **Delete** .

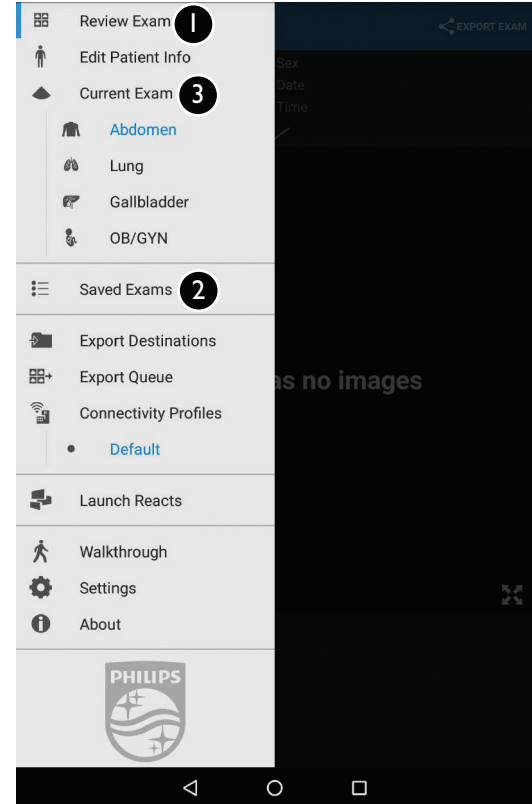



## Exporting Images and Loops

For information on configuring export destinations, see the *User Manual*.

### NOTE

You must end an exam before you can export or e-mail from it.

To e-mail exams or selected images and loops:



- ① Open a saved exam in Review.
- ② Select the images and loops to export:
  - To select the entire exam, touch **Export Exam** .
  - To select individual images and loops, touch and hold each thumbnail to export, until **Done** appears in the upper left of the display. Then touch **Export Selected** .
- ③ Touch **Email**.
- ④ Read the **Notice** statement and touch **Continue**.
- ⑤ If the **Pick an Email Application to Use** dialog box appears, select an e-mail application from the list and touch **Continue**.
- ⑥ Add recipients and text to the e-mail, and then send the e-mail.

To export images and loops to a network destination:

- ① Open a saved exam in Review.
- ② Select the images and loops to export: Touch and hold each thumbnail to export, until **Done** appears in the upper left of the display.
- ③ From the **Export Selected**  menu, select an export destination profile. The images, loops, and, if present, **Fetal Age Summary** export automatically.



## Focus Depth and Brightness

- 1 To change the distance from the face of the transducer to the deepest point on the image, use the **Depth**  dial.
- 2 To adjust image brightness, use the **Gain**  dial.

## Zoom



- 1 To magnify an image, spread two fingers on the image.
- 2 To pan the magnified image, drag with one finger.
- 3 To decrease the magnification, pinch two fingers together on the image.

### NOTE

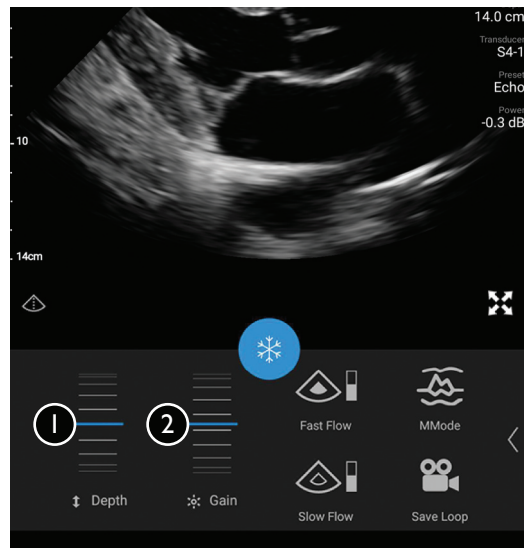
If you spread or pinch inside a color box, you resize the color box instead of zooming.





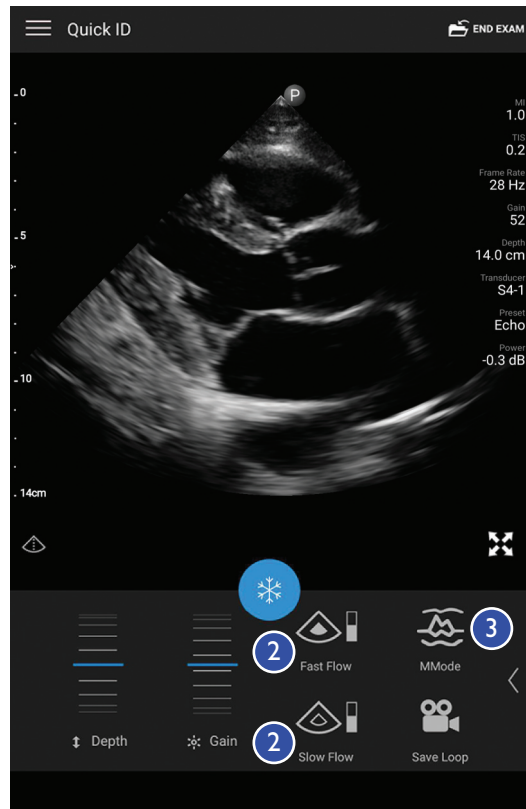

## Imaging Modes

- 1 **2D** mode is the most commonly used imaging mode. The image is displayed in grayscale.
- 2 In the Color modes, an adjustable color box is overlaid on the 2D image:
  - **Fast Flow**  provides a high color scale for arterial flow.
  - **Slow Flow**  provides a low color scale for venous flow.
- 3 **M-Mode** , provides information about the movement of an area of anatomy.





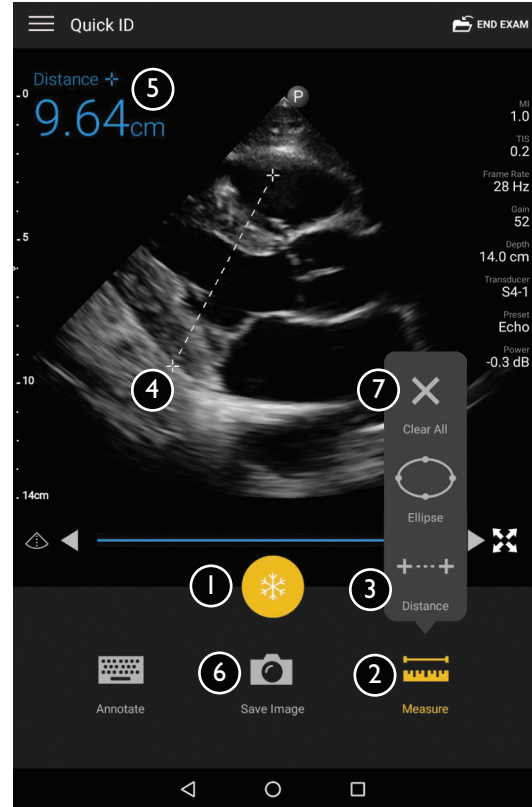

## 2D Distance Measurements

You can add up to four measurements on the image.

- 1 Obtain the 2D image you want to measure and touch .
- 2 Touch **Measure** .
- 3 Touch **Distance** . The distance value appears at the top of the image.
- 4 Drag the first caliper into position.
- 5 Drag the second caliper into position. The results update as the distance between the calipers changes.
- 6 To save an image with the displayed measurements, touch **Save Image** .
- 7 To remove the measurements, touch **Clear All** .



## 2D Ellipse Measurements

- 1 Obtain the 2D image you want to measure and touch .
- 2 Touch **Measure** .
- 3 Touch **Ellipse** . The area and circumference values appear at the top of the image.
- 4 Using the control points, drag the ellipse into position. The results update as you adjust the ellipse.
- 5 To save an image with the displayed measurements, touch **Save Image** .
- 6 To remove the measurements, touch **Clear All** .

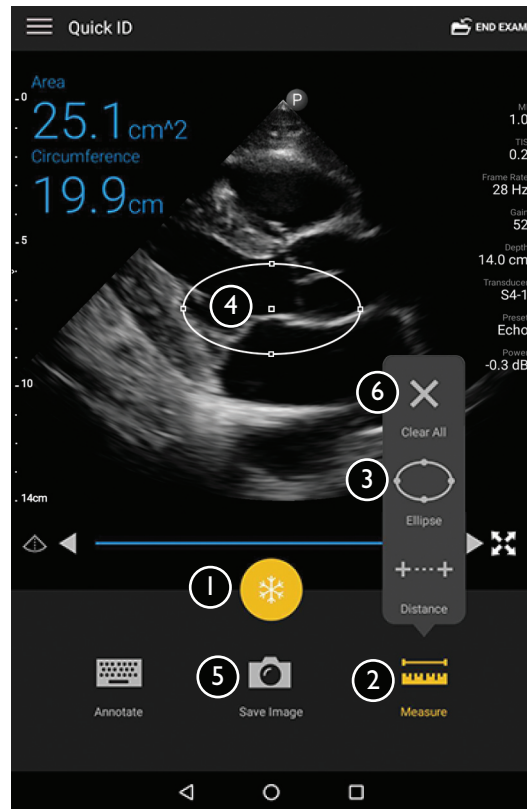





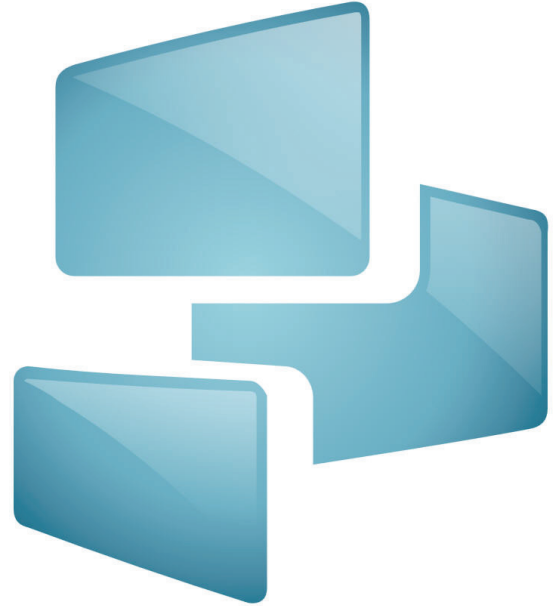

## Lumify with Reacts









Lumify Integrated Tele-Ultrasound Powered by Reacts Collaborative Platform (Lumify with Reacts) is available as a license-based option.







Before you can use Lumify with Reacts, you must create a Reacts account (see the *Lumify User Manual*) and add Reacts contacts (see “Managing Reacts Contacts” on page 24).



## Reacts Controls and Status Icons



Icon	Description
	Reacts icon.
	Touch to exit the Reacts login display and return to the Lumify app.
	Indicates that a contact is active and available for a Reacts session.
	Touch to <b>Add a Pointer</b> to the streamed image.
	Touch to answer the incoming Reacts call.
	Touch to call the contact and start a Reacts session.
	<b>Contacts</b> displays the Reacts Contacts list.

Icon	Description
	Touch to end the call with contact and end the Reacts session.
	Touch to ignore an incoming Reacts call.
	Touch to add Reacts contacts to your contacts list.
	Touch to invite people to Reacts by e-mail.
	Touch to <b>Log Out</b> of Reacts.
	Touch to turn off your device's microphone and mute the Reacts session.
	Indicates that the Reacts contact is offline and unavailable for a Reacts session.
	Indicates that the Reacts contact is pending acceptance of your contact request and unavailable for a Reacts session.

Icon	Description
	Enables you to search in your Reacts contacts list.
	Indicates an active pointer on the streamed image.
	Touch to <b>Share Camera</b> with a remote Reacts user.
	Touch to <b>Stop Camera Share</b> with a remote Reacts user.
	Touch <b>Switch Camera</b> to switch between your device's front and rear cameras.
	Touch to turn on your device's microphone and unmute the Reacts session.
	<b>Walkthrough</b> displays the Reacts tutorial.

## Redeeming or Sharing Reacts Access Codes





You can redeem or share your Reacts access codes. You can also view your access codes on the Reacts login display.

- ① Touch , and then touch **Launch Reacts** .
- ② Touch **Redeem or Share**.
- ③ Do one of the following:
  - Touch **Redeem** and log in to Reacts. Your access code is automatically redeemed. In the **Access Code** dialog box, touch **Okay**.
  - Touch **Share**. On the **Share Reacts Code** form, type the sender and recipient names and e-mail addresses, and then touch **Share**.

For information on creating a Reacts account, see the *Lumify User Manual*.





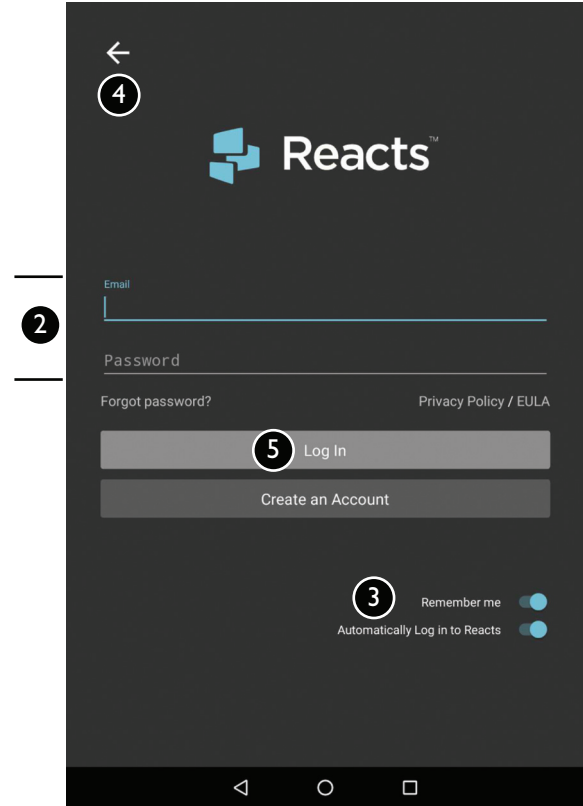

## Logging In to Reacts

- ① To log in, touch , and then touch **Launch Reacts** .
- ② Type the e-mail and password associated with your Reacts account.
- ③ If you want Reacts to remember your login information and automatically log you in next time, select **Remember Me** and **Automatically Log In to Reacts**.
- ④ If you want to return to the Lumify app, touch .
- ⑤ Touch **Log In**.
- ⑥ To log out, touch , and then touch **Log Out** .







## Managing Reacts Contacts

Your Reacts contacts sync with your Reacts license, so if you have Reacts installed on multiple Lumify devices, you can manage your Reacts contacts from any of those devices, using your Reacts login credentials.

- ① To open your contacts list, touch , and then touch **Contacts** .
- ② To add a Reacts contact, touch , type the new contact's e-mail address, and then touch **Send**.
- ③ To remove a Reacts contact, touch and hold the contact, and then touch **Yes**.
- ④ To search for a contact in your contacts list, touch , and then type a name or an e-mail address. Search results appear as you type.



## Starting and Ending a Reacts Session

After you have logged into Lumify with Reacts, you can begin a collaboration session.

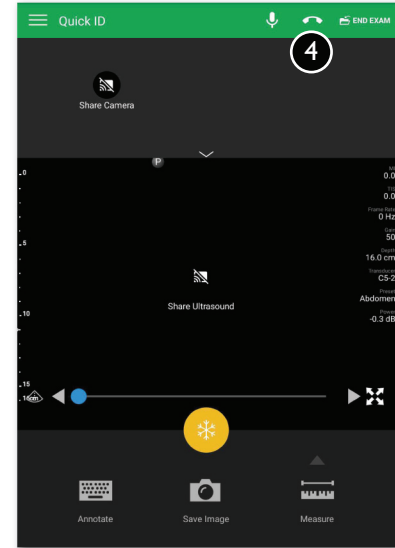
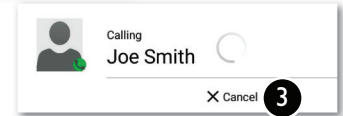
- 1 Touch , and then touch **Contacts** .
- 2 Touch  beside an active contact. When the contact answers your call, the Reacts session is active.
- 3 If you want to end the call before the contact answers, touch **Cancel** .
- 4 To end a Reacts session, touch .



## Using the Reacts Pointer Tool



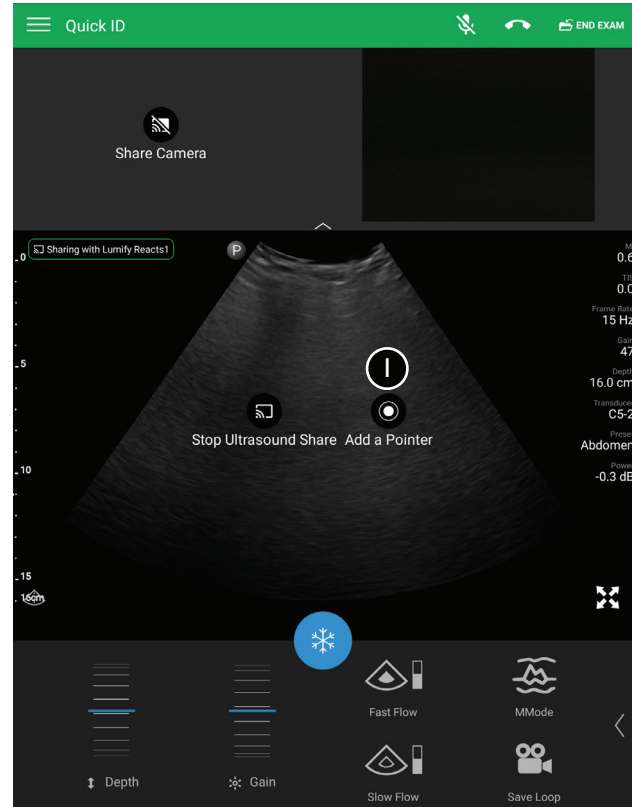



- 1 To add a pointer, touch the streamed image and then touch **Add a Pointer** .
- 2 Drag the pointer  to a location on the streamed image.
- 3 To remove the pointer, touch the streamed image and then touch **Remove Pointer** .



## Sharing Camera and Ultrasound Images

### WARNING

Images viewed remotely via Reacts streaming are intended only for reference and must not be used for diagnostic purposes.

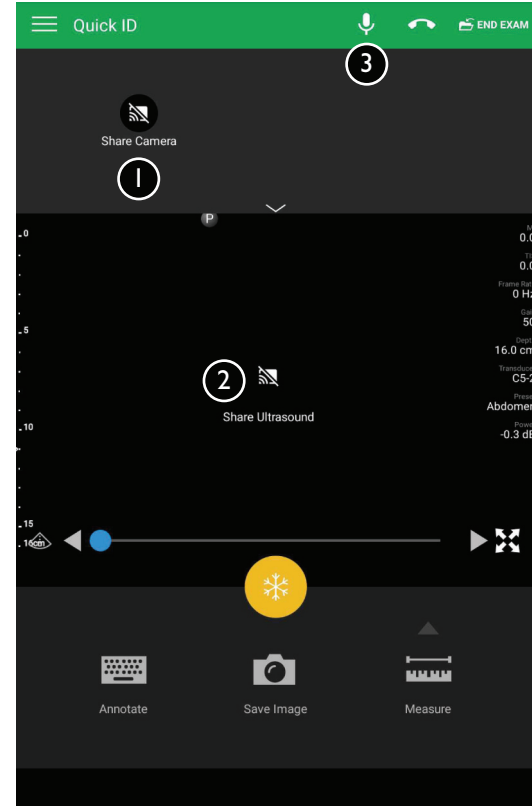

- 1 To share your device's camera image, touch the streamed image, and then touch **Share Camera** . To stop sharing, touch the streamed image and touch **Stop Camera Sharing** .
- 2 To share your ultrasound image, touch the streamed image, and then touch **Share Ultrasound** . To stop sharing, touch the streamed image, and then touch **Stop Ultrasound Share** .
- 3 To turn off your device's microphone and mute the session, touch . To turn on your device's microphone and unmute the session, touch .





## Extending Battery Life

The system includes settings to help extend battery life.

- ① Touch  and select **Settings** .
- ② To display the **Power** control on the imaging display, select **Power Control**.
- ③ To enable the system to reduce the frame rate when you are not actively scanning a patient, select **Power Saving**. Reducing the frame rate saves power and extends battery life.

## Power Management Tips

- Before you turn on your device, disconnect the transducer and all peripheral devices.
- Before you turn off your device, end the current exam.
- For instructions on turning your device on or off, see the documentation that accompanied your device.
- If battery power is unavailable or critically low, disconnect the transducer and charge your device.
- Before imaging, ensure that your device is fully charged.
- To avoid unexpected discharge of the battery, charge your device regularly or when the device displays the low-battery warning.
- If the system does not turn on, verify that the device is fully charged.
- If the system spontaneously reverts to the **Scan/Create Patient** display, verify that the device is fully charged.
- To extend battery life, turn on your device's airplane mode.











© 2018 Koninklijke Philips N.V.

All rights are reserved.

Reproduction or transmission in whole or in part, in any form or by any means, electronic, mechanical or otherwise, is prohibited without the prior written consent of the copyright owner.

Printed in the USA

4535 619 41471 Rev A APR 2018

CE0086

